

Please check the examination details below before entering your candidate information

Candidate surname

Other names

Centre Number

Candidate Number

Pearson Edexcel
Level 1/Level 2 GCSE (9–1)

--	--	--	--	--

--	--	--	--	--

Monday 8 June 2020

Morning (Time: 1 hour 30 minutes)

Paper Reference **1MA1/3F**

Mathematics

Paper 3 (Calculator)

Foundation Tier

You must have: Ruler graduated in centimetres and millimetres, protractor, pair of compasses, pen, HB pencil, eraser, calculator. Tracing paper may be used.

Total Marks

Instructions

- Use **black** ink or ball-point pen.
- **Fill in the boxes** at the top of this page with your name, centre number and candidate number.
- Answer **all** questions.
- Answer the questions in the spaces provided – *there may be more space than you need.*
- You must **show all your working**.
- Diagrams are **NOT** accurately drawn, unless otherwise indicated.
- **Calculators may be used.**
- If your calculator does not have a π button, take the value of π to be 3.142 unless the question instructs otherwise.



Information

- The total mark for this paper is 80
- The marks for **each** question are shown in brackets – *use this as a guide as to how much time to spend on each question.*

Advice

- Read each question carefully before you start to answer it.
- Keep an eye on the time.
- Try to answer every question.
- Check your answers if you have time at the end.

Turn over ►

P62276A

©2020 Pearson Education Ltd.

1/1/1/



Pearson

Answer ALL questions.

Write your answers in the spaces provided.

You must write down all the stages in your working.

- 1 Change 300 centimetres into metres.

..... 3 metres

(Total for Question 1 is 1 mark)

- 2 Work out $\frac{1}{3}$ of 24

$$\frac{1}{3} \times 24$$

..... 8

(Total for Question 2 is 1 mark)

- 3 Write 40% as a fraction.

$$\frac{40}{100}$$

..... $\frac{2}{5}$

(Total for Question 3 is 1 mark)

- 4 Work out 2.5^2

..... 6.25

(Total for Question 4 is 1 mark)

- 5 Write the following numbers in order of size.
Start with the smallest number.

1 -4 0 7 -6 -3 2

..... -6, -4, -3, 0, 1, 2, 7

(Total for Question 5 is 1 mark)

DO NOT WRITE IN THIS AREA

DO NOT WRITE IN THIS AREA

DO NOT WRITE IN THIS AREA



6 The graph shows some information about car production in the UK over eight years.

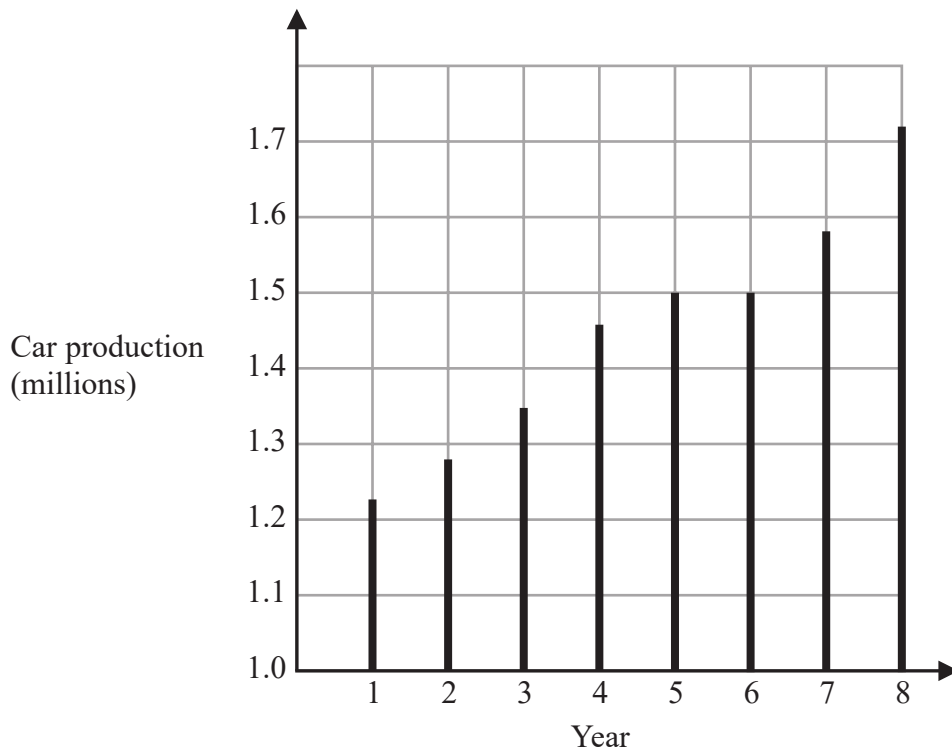

(a) For how many of these years was car production more than 1.4 million?

5
(1)

(b) In which two years was car production the same?

5, 6
(1)

(Total for Question 6 is 2 marks)



7

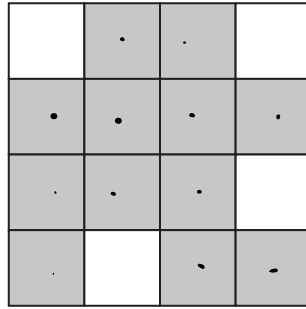

What fraction of the shape is shaded?
Give your answer in its simplest form.

$$\frac{12}{16} = \frac{3}{4}$$

$$\frac{3}{4}$$

(Total for Question 7 is 2 marks)

8 Karim buys 200 tiles.

The tiles are sold in boxes.
There are 25 tiles in each box.
Each box of tiles costs £9.75

Work out the total cost of the boxes of tiles Karim buys.

$$\frac{200}{25} = 8 \quad (\text{boxes})$$

$$8 \times 9.75 = \pounds 78$$

$$\pounds 78$$

(Total for Question 8 is 3 marks)

DO NOT WRITE IN THIS AREA

DO NOT WRITE IN THIS AREA

DO NOT WRITE IN THIS AREA



9 (a) Work out the value of $\frac{300}{2 \times 5}$

$$\frac{30}{(1)}$$

(b) Work out the value of $(6 - 2.5)(8 + 4)$

$$\frac{42}{(1)}$$

(c) Write down the reciprocal of 20

$$\frac{1}{20}$$

(1)

(Total for Question 9 is 3 marks)



- 10 The graph shows information about the time, in minutes, a liquid has been cooling and the temperature of the liquid in $^{\circ}\text{C}$.

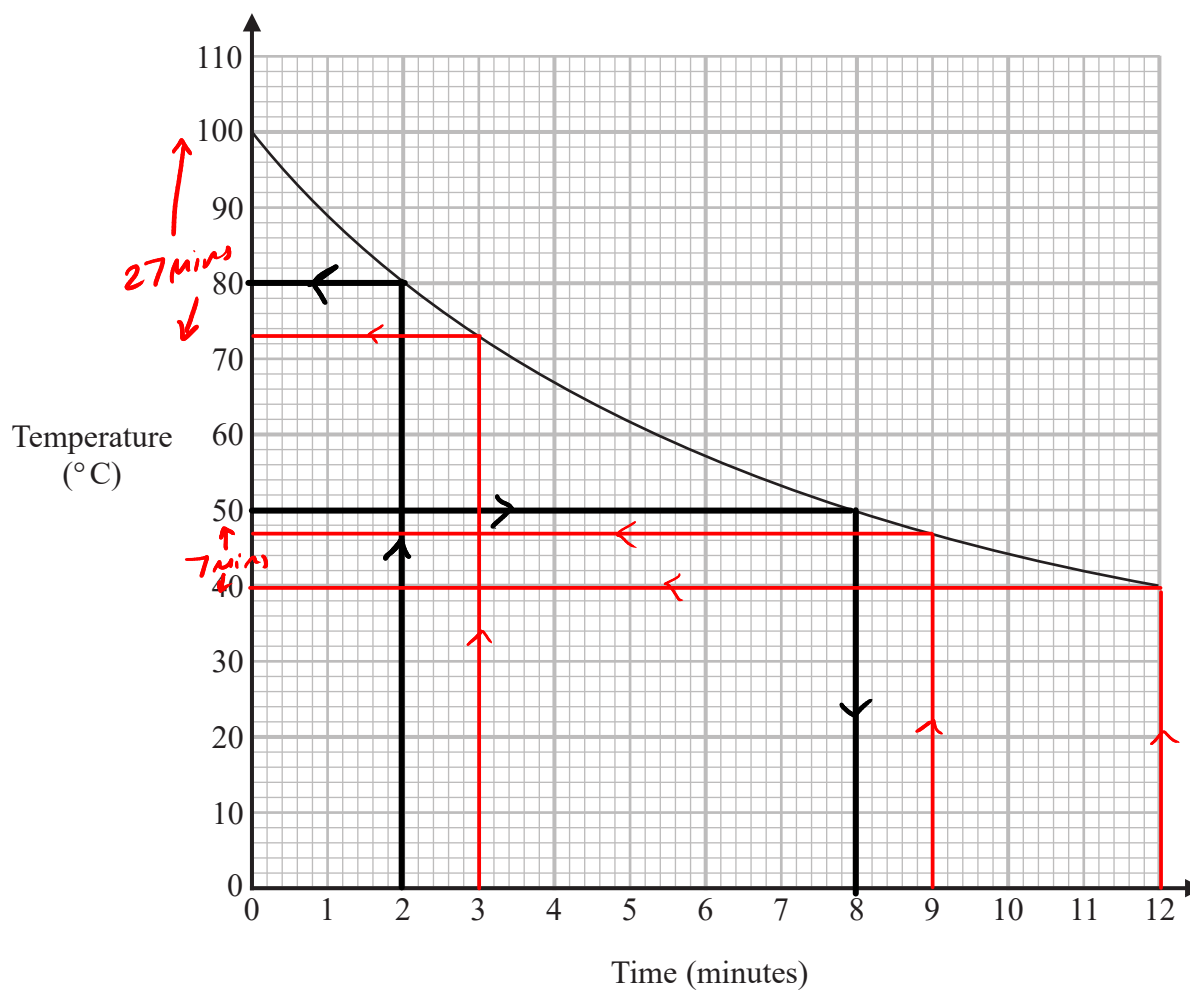

- (a) What is the temperature of the liquid at time 2 minutes?

..... 80 $^{\circ}\text{C}$
(1)

Pam recorded the time when the liquid had a temperature of 50°C .

- (b) Write down this time.

..... 8 minutes
(1)



Pam says that the temperature of the liquid drops more in the first 3 minutes of cooling than it does between time 9 minutes and time 12 minutes.

(c) Is Pam correct?

Give a reason for your answer.

Yes. Drop in first 3 mins = 27°

Drop 9-12 mins = 7°

$27^\circ > 7^\circ$

(1)

(Total for Question 10 is 3 marks)

- 11 $PQRS$ is a quadrilateral.
 PST is a straight line.

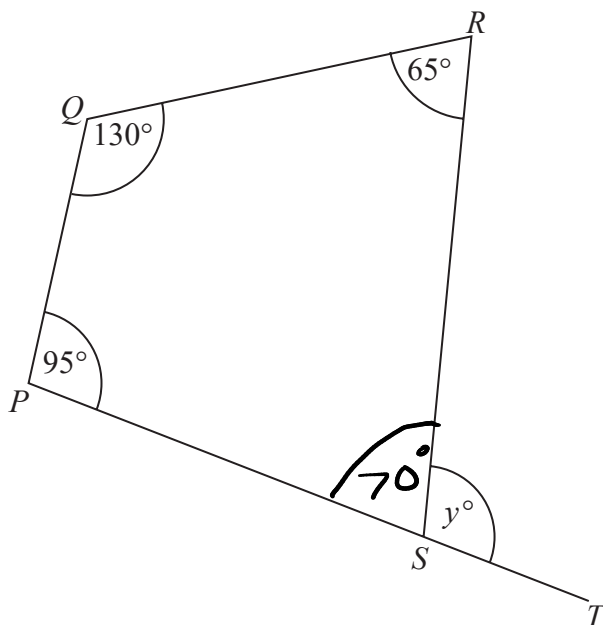

Find the value of y .

$$360 - 130 - 95 - 65 = 70$$

$$180 - 70 = \underline{110^\circ}$$

$$y = \underline{110^\circ}$$

(Total for Question 11 is 3 marks)



12 Here are the first five terms of a number sequence.

45 40 35 30 25

(a) (i) Write down the next two terms of this sequence.

20, 15
(1)

A term of this sequence is -5

(ii) Which term?

6	7	8	9	10	11
20	15	10	5	0	-5

11th
(1)

The n th term of a different sequence is given by the expression $4n + 3$

(b) Find the 9th term of this sequence.

$$4(9) + 3$$

39
(1)

(Total for Question 12 is 3 marks)



13

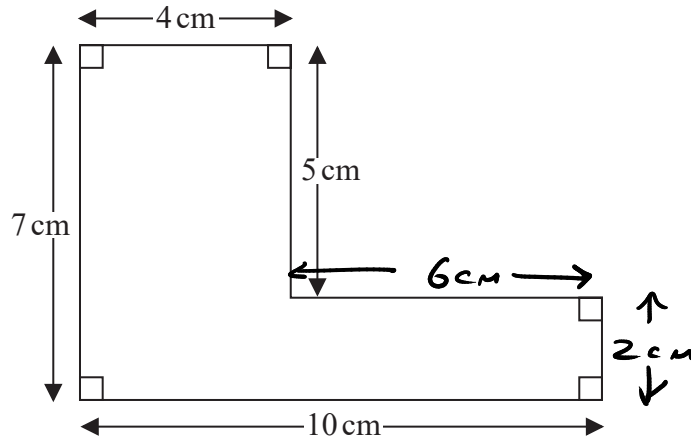

Work out the perimeter of this shape.

$$10 + 7 + 4 + 5 + 6 + 2 = 34 \text{ cm}$$

..... 34 cm

(Total for Question 13 is 2 marks)

14 (a) Simplify $3x + 5y + 2x - 4y$

$$5x + y$$

..... $5x + y$
(2)

(b) Solve $5p + 7 = 22$

$$5p = 15$$

$$p = 3$$

$p =$ 3
(2)

(Total for Question 14 is 4 marks)



P 6 2 2 7 6 A 0 9 2 4

15 Here are the costs of the same type of batteries in two shops.

Shop A
Pack of 4 batteries
£1.60

Shop B
Pack of 6 batteries
£2.70

Harry needs to buy at least 30 batteries.

He assumes that he has to buy batteries in whole packs.

Harry wants to buy the batteries as cheaply as possible from the same shop.

(a) Which shop should he buy the batteries from, shop A or shop B?

You must show all your working.

$$\text{Shop A: } \frac{30}{4} = 7.5 \text{ (8 packs)}$$

$$£1.60 \times 8 = £12.80$$

$$\text{Shop B: } \frac{30}{6} = 5 \text{ packs}$$

$$£2.70 \times 5 = £13.50$$

Shop A

(4)

Harry's assumption is wrong.

He can buy single batteries for 40p each in shop A and for 45p each in shop B.

(b) Does this affect which of these two shops Harry should buy the batteries from?

Give a reason for your answer.

No He will have to pay less in shop A and shop B will still be the same price

(1)

(Total for Question 15 is 5 marks)



16 There are only 5 blue cards, 2 green cards and 4 red cards in a pack.

Isabella is going to take at random one card from the pack.

(a) Write down the probability that Isabella will take a blue card.

$$5 + 2 + 4 = 11$$

$$\frac{5}{11}$$

(2)

Ken is going to throw a biased dice once.

The probability that the dice will land on six is 0.3

(b) What is the probability that the dice will **not** land on six?

$$1 - 0.3$$

$$0.7$$

(1)

(Total for Question 16 is 3 marks)



17 Draw accurately an isosceles triangle with sides of length 8 cm, 6 cm and 6 cm.
One side of the triangle has been drawn for you.

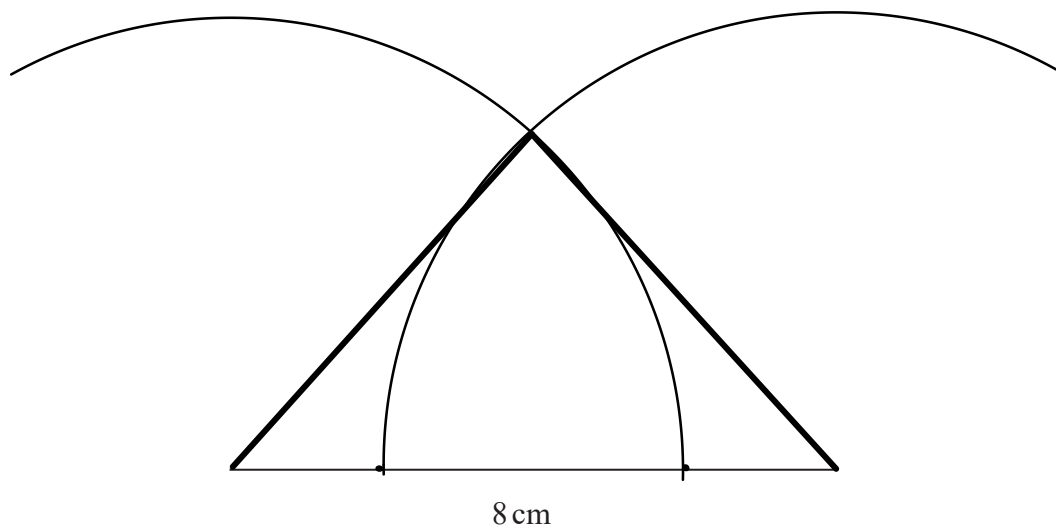

(Total for Question 17 is 2 marks)

DO NOT WRITE IN THIS AREA

DO NOT WRITE IN THIS AREA

DO NOT WRITE IN THIS AREA



DO NOT WRITE IN THIS AREA

DO NOT WRITE IN THIS AREA

DO NOT WRITE IN THIS AREA

18 This graph can be used to change between US dollars (\$) and British pounds (£).

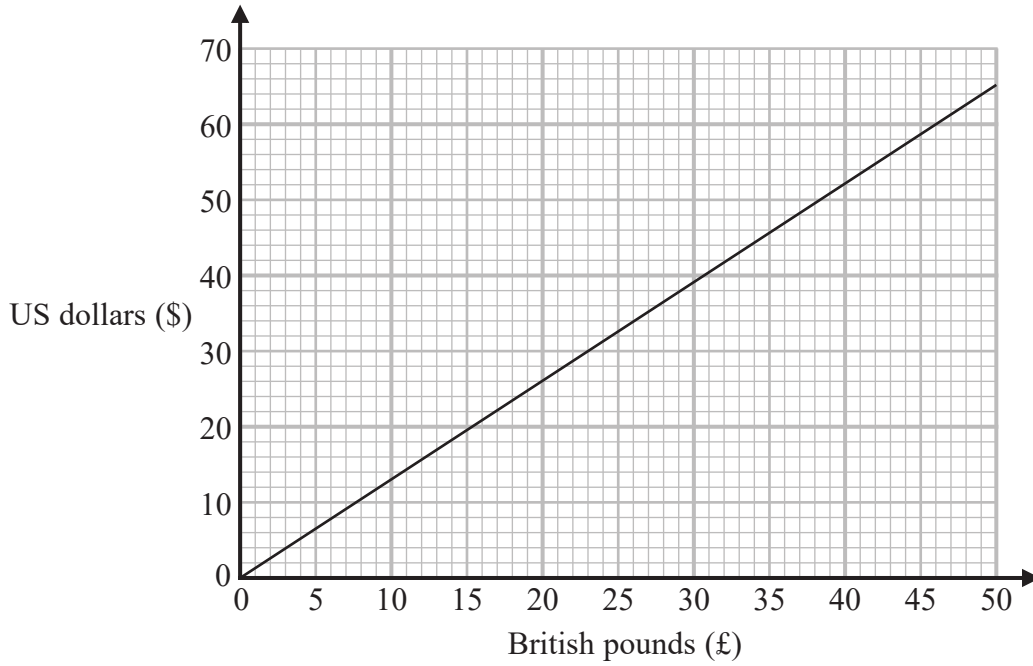

Rosie bought a ring in the USA.
She paid 345 US dollars.

Work out in pounds the amount Rosie paid for the ring.

$$\begin{array}{r}
 \$60 = £45 \\
 \div 60 \qquad \div 60 \\
 \$1 = £0.75 \\
 \times 345 \qquad \times 345 \\
 \$345 = £258.75
 \end{array}$$

£ 258.75
 (258 → 275)
 (Total for Question 18 is 3 marks) ↑

acceptable answers



19 Here are the types of sandwiches sold in a cafe last week.

Sandwiches
Tuna
Cheese
Chicken
Egg

56 tuna sandwiches were sold.

This was 40% of the total number of sandwiches sold.

(a) Work out the total number of sandwiches sold.

$$\begin{aligned}
 40\% \text{ of total} &= 56 \\
 \div 4 & \\
 10\% \text{ of total} &= 14 \\
 \times 10 & \\
 100\% &= 140
 \end{aligned}$$

$$\begin{array}{r}
 140 \\
 \hline
 (2)
 \end{array}$$

Of the 56 tuna sandwiches sold, 18 were sold on Friday.

(b) Write 18 as a percentage of 56

Give your answer correct to the nearest whole number.

$$\frac{18}{56} \times 100 = 32$$

$$\begin{array}{r}
 32 \\
 \hline
 (2) \quad \%
 \end{array}$$

(Total for Question 19 is 4 marks)



DO NOT WRITE IN THIS AREA

DO NOT WRITE IN THIS AREA

DO NOT WRITE IN THIS AREA

20 Akhtar, Ben and Carl each have some money.

Akhtar has £65

Ben has £100

Carl has three £5 notes, one £20 note and some £10 notes.

The mean amount of money per person is £80

How many £10 notes does Carl have?

$$\frac{\text{total}}{3} = 80$$

$$\text{total} = \pounds 240$$

$$240 - 65 - 100 = \pounds 75 \quad (\text{Carl has } \pounds 75)$$

$$3 \times 5 = 15$$

$$15 + 20 = 35$$

$$75 - 35 = 40$$

← £40 in £10 notes

$$\frac{40}{10} = 4$$

4

(Total for Question 20 is 4 marks)



21 Malik is going to throw a fair coin 50 times.

(a) Write down an estimate for the number of times the coin will land on heads.

25

(1)

Paula and Simon are trying to find out if a different coin is biased.

Paula throws this coin 10 times.

She records the number of times the coin lands on heads.

Simon throws the same coin 100 times.

He records the number of times the coin lands on heads.

(b) Whose results will be more useful in deciding if the coin is biased?

Give a reason for your answer.

Simon's results because he has more trials.

(1)

(Total for Question 21 is 2 marks)



- 22 Here is a solid made from a square-based pyramid and a cube.
Each edge of the solid has length 6 cm.

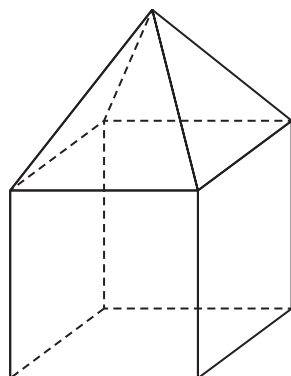

On the centimetre grid, draw the plan of this solid.

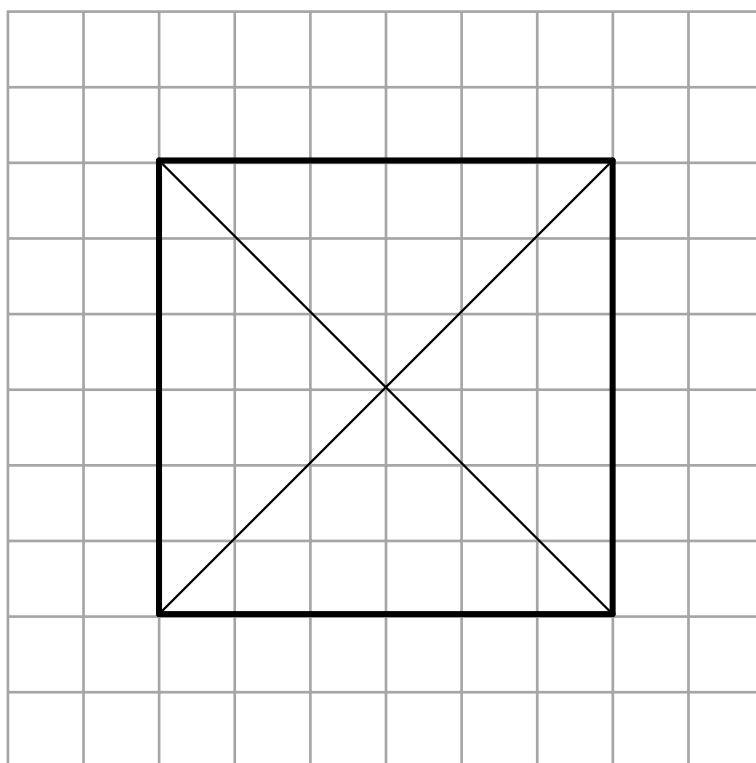

(Total for Question 22 is 2 marks)



23 (a) Simplify $n^3 \times n^5$

$$n^8$$

(1)

(b) Simplify $\frac{c^3d^4}{c^2d}$

$$cd^3$$

(2)

(c) Solve $\frac{5x}{2} > 7$

$$5x > 14$$

$$x > \frac{14}{5}$$

$$x > \frac{14}{5}$$

(2)

(Total for Question 23 is 5 marks)

DO NOT WRITE IN THIS AREA

DO NOT WRITE IN THIS AREA

DO NOT WRITE IN THIS AREA



DO NOT WRITE IN THIS AREA

DO NOT WRITE IN THIS AREA

DO NOT WRITE IN THIS AREA

24 Andy cycles a distance of 30 km at an average speed of 24 km/h.
He then runs a distance of 12 km at an average speed of 8 km/h.

Work out the total time Andy takes.
Give your answer in hours and minutes.

$$\text{Speed} = \frac{\text{distance}}{\text{time}}$$

$$\text{time} = \frac{\text{distance}}{\text{speed}}$$

$$\text{Part 1 : } \frac{30}{24} = 1.25 = 1 \text{ hr } 15 \text{ mins}$$

$$\text{Part 2 : } \frac{12}{8} = 1.5 = 1 \text{ hr } 30 \text{ mins}$$

$$1 \text{ hr } 15 \text{ min} + 1 \text{ hr } 30 \text{ mins}$$

$$= 2 \text{ hrs } 45 \text{ mins}$$

..... 2 hours 45 minutes

(Total for Question 24 is 3 marks)

25 A number, m , is rounded to 1 decimal place.
The result is 9.4

Complete the error interval for m .

$$9.35 \leq m < 9.45$$

(Total for Question 25 is 2 marks)



26 Maisie knows that she needs 3 kg of grass seed to make a rectangular lawn 5 m by 9 m.

Grass seed is sold in 2 kg boxes.

Maisie wants to make a rectangular lawn 10 m by 14 m.

She has 5 boxes of grass seed.

(a) Has Maisie got enough grass seed to make a lawn 10 m by 14 m?

You must show all your working.

$$5 \times 9 = 45 \text{ m}^2$$

$$45 \text{ m}^2 \text{ needs } 3 \text{ kg}$$

$$15 \text{ m}^2 \text{ needs } 1 \text{ kg}$$

$$30 \text{ m}^2 \text{ needs } 2 \text{ kg}$$

Each box covers 30 m^2

$$5 \text{ boxes } \quad 5 \times 30 = 150 \text{ m}^2$$

$$10 \times 14 = 140 \text{ m}^2$$

$$\text{Yes. } 150 \text{ m}^2 > 140 \text{ m}^2$$

(4)

Maisie opens the 5 boxes of grass seed.

She finds that 4 of the boxes contain 2 kg of grass seed.

The other box contains 1 kg of grass seed.

(b) Does this affect whether Maisie has enough grass seed to make her lawn?

Give a reason for your answer.

Yes. 1 kg of grass seed covers 15 m^2

She now only has enough for 135 m^2

(1)

(Total for Question 26 is 5 marks)



27 Amanda has two fair 3-sided spinners.

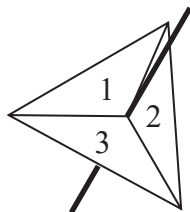

Spinner A

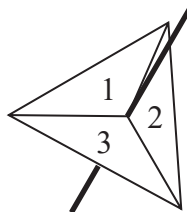

Spinner B

Amanda spins each spinner once.

(a) Complete the probability tree diagram.

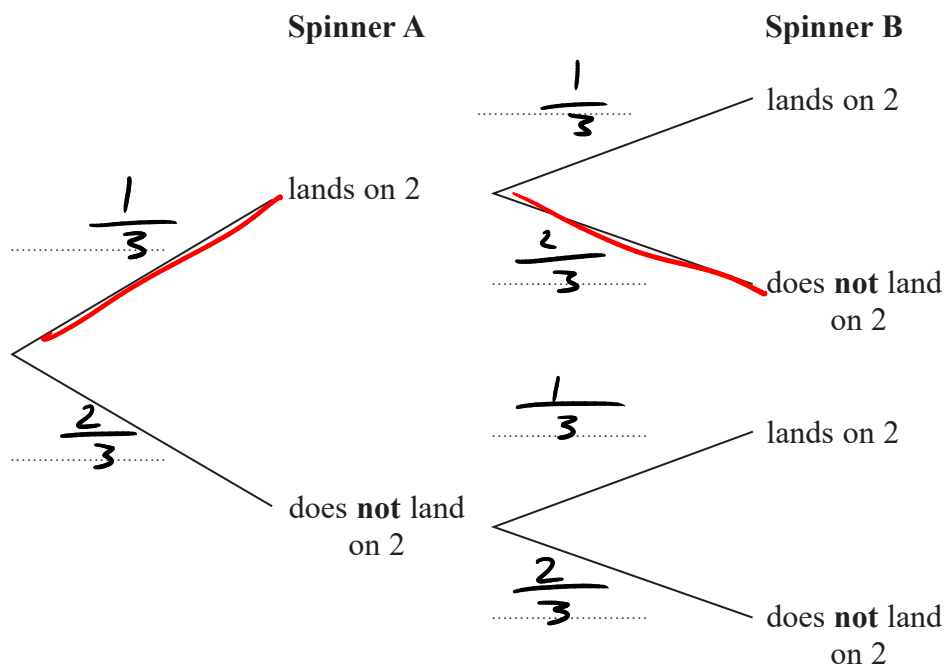

(2)

(b) Work out the probability that Spinner A lands on 2 and Spinner B does **not** land on 2

$$\frac{1}{3} \times \frac{2}{3}$$

$$\frac{2}{9}$$

(2)

(Total for Question 27 is 4 marks)



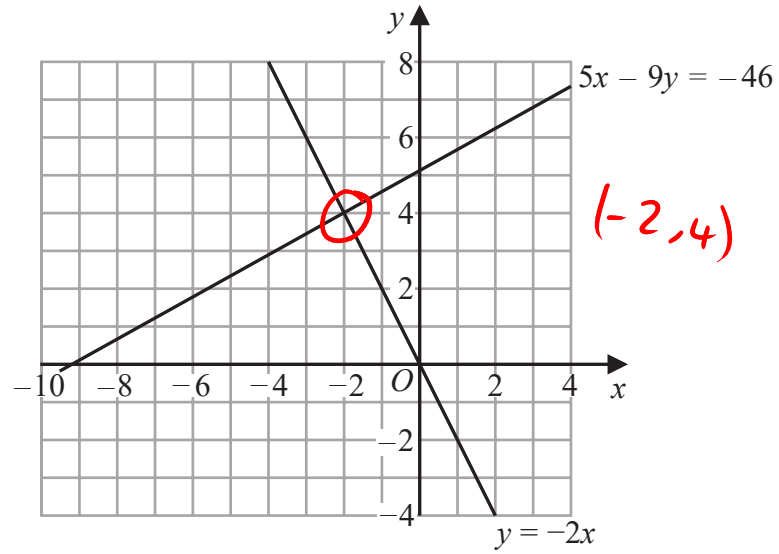

(a) Use these graphs to solve the simultaneous equations

$$\begin{aligned} 5x - 9y &= -46 \\ y &= -2x \end{aligned}$$

$$\begin{aligned} x &= \dots -2 \dots \\ y &= \dots 4 \dots \\ &\quad (1) \end{aligned}$$



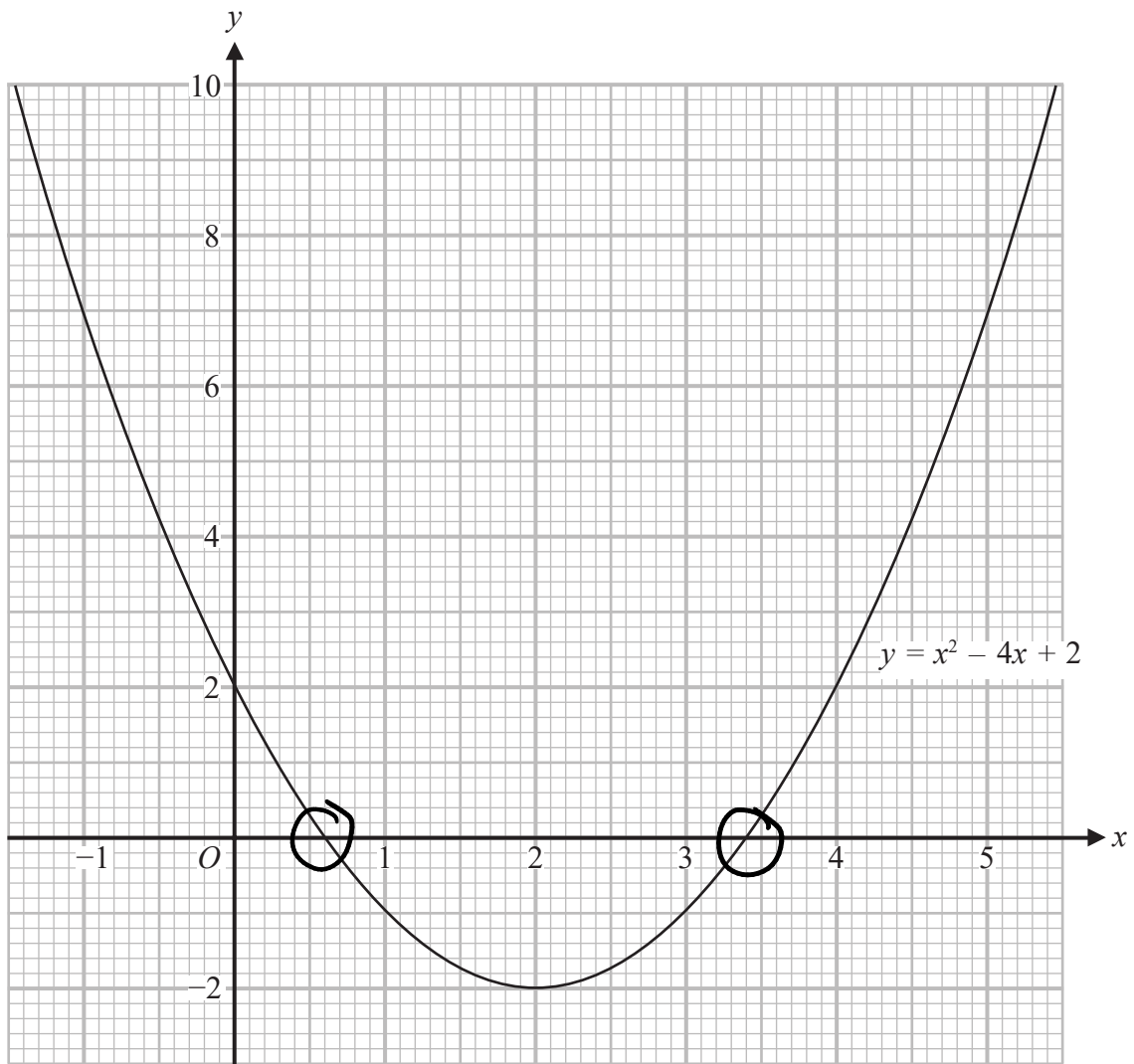

(b) Use this graph to find estimates for the solutions of the quadratic equation $x^2 - 4x + 2 = 0$

$$x = 0.6 \text{ or } x = 3.4$$

(2)

(Total for Question 28 is 3 marks)



29 The diagram shows a solid triangular prism.

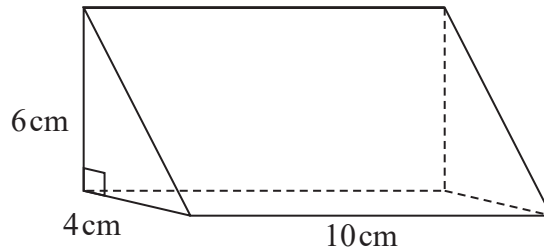

The prism is made from wood with a density of 0.8 g/cm^3

Work out the mass of this prism.

$$\text{density} = \frac{\text{mass}}{\text{volume}}$$

$$\begin{aligned}\text{mass} &= \text{density} \times \text{volume} \\ &= 0.8 \times \text{volume}\end{aligned}$$

$$\begin{aligned}\text{volume} &= \text{area of triangle} \times 10 \\ &= \frac{1}{2} \times 4 \times 6 \times 10 \\ &= 120 \text{ cm}^3\end{aligned}$$

$$\begin{aligned}\text{mass} &= 0.8 \times 120 \\ &= 96 \text{ g}\end{aligned}$$

..... 96 g

(Total for Question 29 is 3 marks)

TOTAL FOR PAPER IS 80 MARKS

DO NOT WRITE IN THIS AREA

DO NOT WRITE IN THIS AREA

DO NOT WRITE IN THIS AREA

